



USER MANUAL

CONTENTS

General Notice	2
Precautions	3
Safety Notice	4
Download APP and Register	6
Rapid Installation	8
Parts Info	10
Operation Guide	15
Battery Use and Maintenance	22
DOs and DON'Ts while Riding	28
Maintenance and Repair	30
Troubleshooting List	34
Technical Parameters	41
Maintenance Record	46

General Notice

- △ Please read this User Manual carefully for proper operation before riding the scooter.
- △ For your safety, please check whether the parts are in good condition according to this User Manual before riding. Contact your dealer in time in case of any problems.
- △ Please follow the traffic laws. Slow down on slippery roads in bad weather to allow greater braking distance for your safety.
- △ Please pay attention to deep water. It may cause rusting or failure of the motor, battery or other parts if water level reaches wheel axle.
- △ Do not dismantle the scooter on your own. Please contact your dealer for replacement or purchase of original parts.
- △ Do not lend your M1 to those who can't operate a scooter for others' safety and preventing unnecessary damage to your scooter.
- △ Please keep this User Manual properly.

Precautions

△ Rider and Passenger

M1 is not designed for a ride of more than 2 persons.

△ Riding Conditions

M1 is not designed for off-road use.

△ This User Manual should be deemed as a permanent document of M1. If this scooter is transferred to others, this User Manual should also be handed over to the new owner.

△ Reproduction or reprint of any part of this User Manual is strictly prohibited.

Warning: Failure to follow the instructions herein may lead to serious casualties.

Attention: Failure to follow the instructions herein may lead to personal injury or scooter damage.

Safety Notice

- △ Using a safety helmet and protective goggles is strongly advised.
- △ You are advised to take proper training or exercise before using on open roads.
- △ Please follow the Operation Guide (P.15) to fully understand how to properly operate the scooter.
- △ It should be noted that the braking distance in bad weather will be much longer. Please avoid braking on paint markers, manhole covers and oil stains to prevent slipping. Pay extra attention when riding through railway crossings, junctions, tunnels, and bridges. Slow down if road conditions are unclear.

- △ Do not use high beam indiscriminately. Continuous use of high beam may disturb the vision of the drivers and pedestrians.
- △ Do not use mobile phones or other electronic devices which may draw your attention while riding.
- △ Do not change the lane without signaling. Changing the lane at will is one of the major causes for accidents. When you need to change the lane, remember to switch on the Turn Signal Indicator first. Always check the vehicles approaching from behind before changing the lane.

Download APP and Register

- ① Scan the QR code below to download the APP titled NIU Scooter.



- ② Run Setup after downloading and register.

③ Scan the QR code below for scooter binding after registration.



Attach the
SN Code here

Note:

The mobile phone system is required to be at least Android 4.0 or iOS 8. Make sure that the mobile phone has been connected to the Internet when running NIU app (Wi-Fi/2G/3G/4G).

Rapid Installation

- ① Open the Accessories Box to take the tools
- ② Align the windshield rubber part with the windshield holes and then install it.
- ③ Tighten the two screws with a screwdriver to secure the windshield.

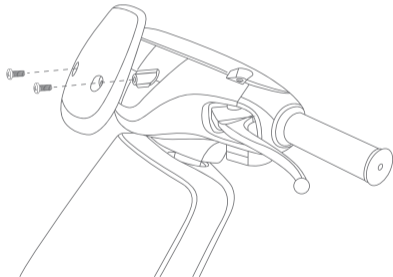
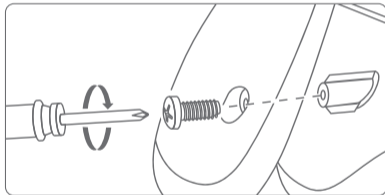

- ④ Install the rearview mirrors into the mounting holes on dashboard and turn it clockwise. The bolt shall be screwed in for more than 15mm.
- ⑤ Adjust the rearview mirror to an appropriate position and then tighten nuts on the rearview mirror with a spanner. Properly set the dust cover.

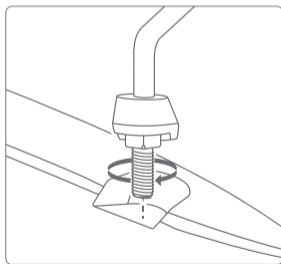
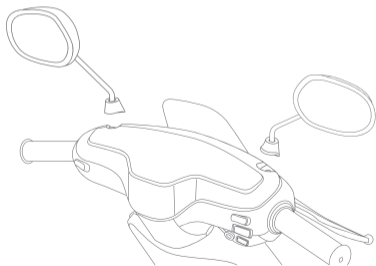

Parts Info

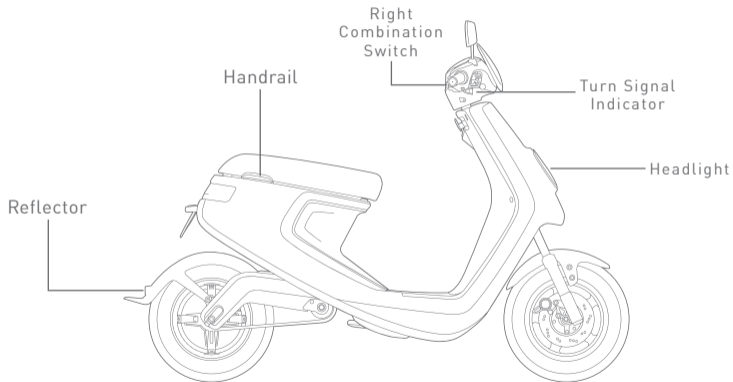



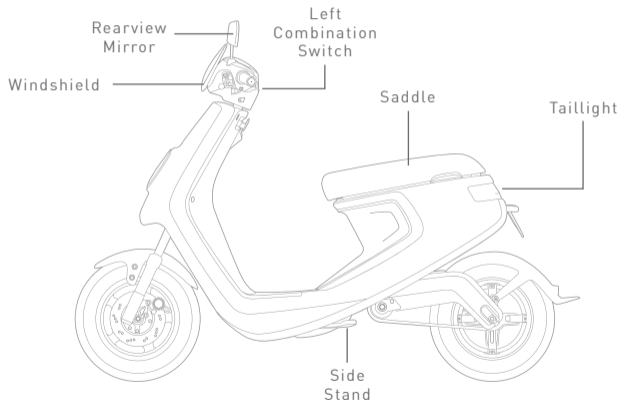

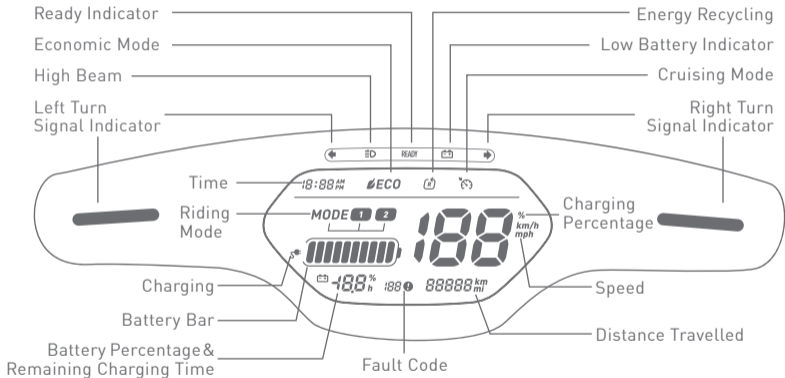

Parts Info



Dashboard Display Info



Dashboard Display Info

	Left Turn Signal Indicator	The Left Turn Signal Indicator is on.
	Right Turn Signal Indicator	The Right Turn Signal Indicator is on.
	High Beam	The High Beam is on.
READY	Ready Indicator	In riding Mode.
	Low Battery Indicator	Battery level less than 20%.
12:00 PM	Time	Now is 12:00 pm.
	Economic Mode	Ideal energy consumption status.
	Energy Recycling Status	Energy is being recycled from braking.
MODE 	Riding Mode	Mode 2 is selected.

Dashboard Display Info

26^{km/h}

Speed

Current speed is 26km/h.

13[%]

Charging Percentage (Large)

Current battery charging progress is 13%.



Battery Bar

Current battery level.

E: Low battery (less than 10%)

F: Full battery (more than 90%)

89[%]

Battery Percentage (Small)

Battery level in percentage is 89%.

- 3.2^h

Remaining Charging Time

The remaining charging time is 3.2 hours.



Charging

The battery is being charged.

00802^{km}

Distance Travelled

Distance Travelled is 802km.

Operation Guide

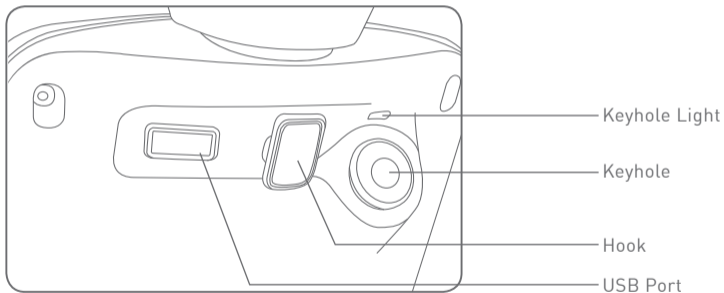

Operation Guide

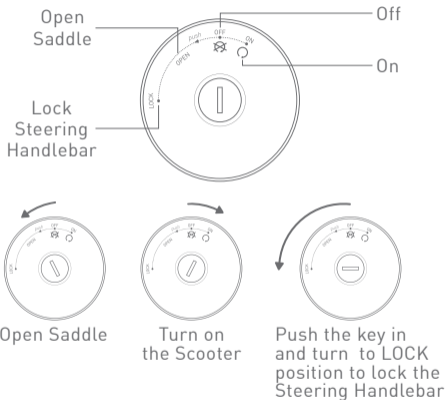
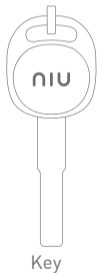

Operation Guide

△ Start the Scooter

Press the Unlock button of the remote controller. After the Turn Signal Indicators flash twice, the scooter is unlocked. Insert the key into the Keyhole and turn to . Press and hold the Start Button for 2 seconds, **READY** on Dashboard will light on. You are ready to go.

△ Locking the scooter

Turn the key to  to turn off the scooter. Turn the steering handlebar to the left, then push the key inward and turn to **LOCK** to lock Steering Handlebar. Press the Lock Button on the Remote Controller within an effective distance to turn on the Alarm. The Turn Signal Indicators will stay on for 2 seconds after the scooter is properly locked.

△ Locating

Press the Locating Button and the Turn Signal Indicators will flash for 10 seconds. If no further operation during this period, the Alarm will be on for 10 seconds. The Alarm can be cancelled by pressing the Unlock or Lock Button.

Operation Guide

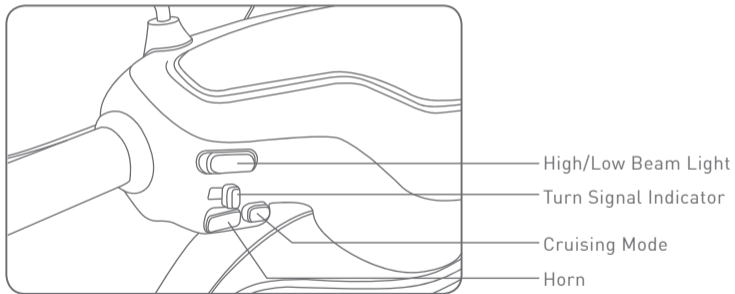

High/Low Beam: Press the right part to turn on the high beam; press the left part to turn on the low beam. To signal overtaking with flashing light, the rider may press and release the Pass button repeatedly.



Turn Signal Indicator: Push the button left to turn on the Left Turn Signal Indicator; push the button right to turn on the Right Turn Signal Indicator. Press the button to reset and the Turn Signal Indicator will be off.

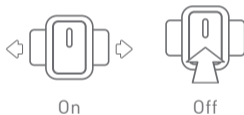

Cruising Mode: Push the button to cruise at current speed. Press again or brake to turn it off.



Operation Guide

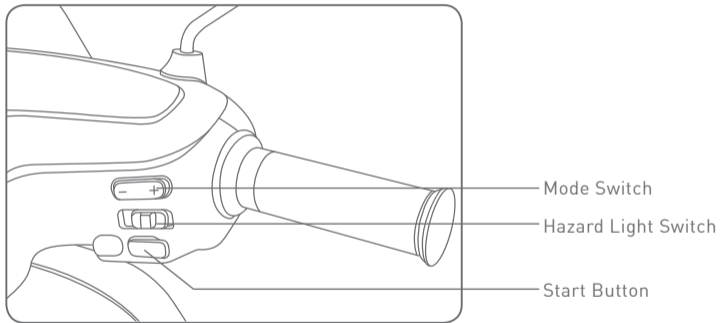

Mode Switch: Press left part to switch to Mode 1(Eco Mode). Press right part to switch to Mode 2(Sport Mode).



Hazard Light Switch: Push the switch left to turn on the Hazard Light; push the switch right to turn it off.



Start Button: Press and hold the Start button for 2 seconds to start the scooter. The **READY** on the dashboard will light up. Press the button again to turn it off.



Battery Use and Maintenance

△ Battery Level Indicator

- ① When the Indicator Button is pressed, the Indicator will light up to show the percentage of the battery. The indicator has 5 sections. Each presents 20% of the battery level.
- ② If the battery level is less than 20%, the Indicator will flash 3 times.
- ③ When charging, the indicator will flash to show the charging progress. They will stop flashing when the battery is fully charged.
- ④ If all 5 sections flash, it means the battery has fault. Please contact your dealer for consultation.

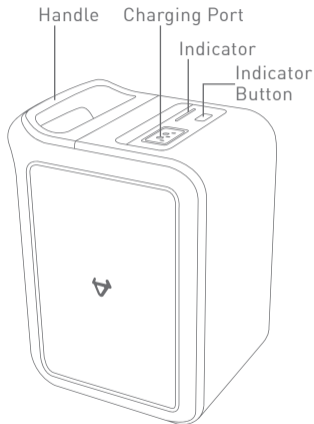

Battery Use and Maintenance

△ Using Environment

In order to prevent possible leakage, overheat, smoking, fire or explosion, please follow these instructions:

- ① The battery should be used at the temperature of -10°C to 45°C.
- ② Do not expose to water, beverages or corrosive liquids.
- ③ Keep away from heat source, open fire, inflammable and explosive gases and liquids.
- ④ Please keep metal parts away from the battery compartment.
- ⑤ In case of undesirable odor, overheat or deformation of the battery, please disuse the battery immediately, keep away from the battery and contact your dealer.

Warning: The M1 battery is NOT a repairable part by the user. In case of battery fault, please contact your dealer. Users dismantling the battery may lead to leakage, overheat, smoking, fire or explosion. **Do not attempt to open or repair the battery, as any attempt to do so will render the warranty invalid.**

Battery Use and Maintenance

△ Charging Environment

The battery should be charged at the temperature of 10°C to 35°C. The charging time should not exceed 24 hours. Overcharging will shorten the battery life.

Attention: Do not charge the battery below 0°C.

Warning: Using non-original battery chargers may lead to leakage, overheat, smoking, fire or explosion.

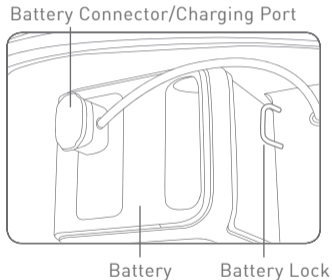

Battery Use and Maintenance

△ Charging Methods

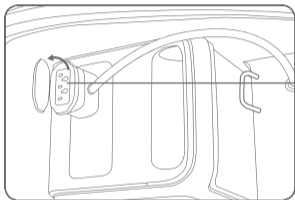

Charging Port

Charging on the Scooter

Open the saddle, open the cover of the connector, and plug the charger into the charging socket.

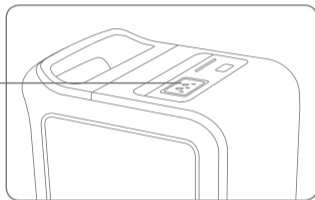

Charging the Battery

Remove the battery from the scooter. Connect the charger with battery and socket.

Warning:

- △ All operation should be strictly conform to the user manual. If not, result will be assumed by user.
- △ Must use original charger
- △ Pay attention to the type of battery and applied voltage. Mixture use is forbidden.
- △ Charging should be in ventilated environment. DO NOT charge in closed space or under high temperature. DO NOT put charger into trunk or tail box while charging.
- △ While charging, connect battery with charger before connect with electric supply. After full charged, cut off the electric supply before cut off the battery plug.
- △ When the green light turns on, please cut off the power in time. Avoid long time connection between charger and AC power supply while not charging.
- △ While charging, if the signal light is abnormal, has different smell or the charger is over temperature, please stop charging immediately and check or change the charger in time.
- △ When using and storing the charger, please avoid foreign matter, especially water or other liquid in case of internal short circuit. DO NOT bring charger within scooter, if have to, please make sure of damping.
- △ DO NOT disassemble or change the parts in charger by yourself.

Attention:

- △ If the battery can not be fully charged after 12 hours, please stop charging and contact your dealer.
- △ To maximize the battery life, please keep the battery percentage within 20% to 80%.
- △ For storage, please keep the battery under 40°C to prevent irreversible capacity loss of the battery.
- △ M1 battery will lose more capacity in lower temperature conditions. To be more specific, the usable capacity at -10°C is 70%, 85% at 0°C and 100% at 25°C.
- △ The best battery capacity performance for storage is 50%. Storing battery with less than 10% or more than 90% over a long period of time will cause irreversible capacity loss to the battery.
- △ **The battery needs to take out from the scooter for storage longer than one week.** In this condition, please keep the battery at the temperature of 0°C to 20°C with capacity of 30%-70%. It's advised to have at least one cycle of charge and discharge every 2 months to minimize battery capacity loss during storage. **If the battery failure is due to misuse or lack of proper maintenance as instructed, its warranty will be invalidated.**
- △ Falling may cause uncontrollable internal damage to the battery and may cause leakage, overheat, smoking, fire or explosion.

DOs and DON'Ts while Riding

△ Before Riding: Please check the following details before riding.

Check Point	Description
Steering Handlebar	<ol style="list-style-type: none">1. Steadiness2. Steering flexibility3. No axial displacement or loosening
Braking	<ol style="list-style-type: none">1. Braking lever has 5 to 9mm idle travel.
Tyres	<ol style="list-style-type: none">1. The air pressure range of both tires is 25 to 34psi.2. Proper tyre tread depth3. No cracks or openings
Battery	Adequate for planned distance to travel
Lights	Check all the lights—High Beam, Low Beam, Brake Light, Turn Signal Indicator, etc.
Horn	Check whether the horn can work.

DOs and DON'Ts while Riding

△ Braking Precautions

Adjust the scooter upright before applying brakes.

If the tyres are locked and the scooter lose steering ability resulting from excessive braking force, loosen the grip on the braking lever and the tyres will be working again and the scooter will be stabilized.

Try to maintain a 1:1 ratio of front and rear braking force on slippery roads.

Attention:

Inexperienced riders tend to use the rear brake only, which will accelerate the wear of the brake and result in a longer braking distance.

Warning:

Using the front brake or rear brake only is dangerous because of possible grip or control loss. Pay extra attention and use the brakes gently when riding on damp, slippery roads and around corners. Otherwise, riders will be exposed to great danger.

Maintenance and Repair

Users are advised to have the scooter checked and maintained on a regular basis, even for the scooters that are not used for a long time.

△ Regular Maintenance

Users are advised to have their scooters checked 2 months after purchased or with 500km travelled distance. Overall check and maintenance is advised to be conducted every 6 months or 3000km thereafter.

△ Daily Maintenance

If any problem occurs during checks, please look through the Home Repair Instructions or send the scooter to the dealer's for checks and maintenance.

△ Scooter Washing

Please use neutral detergent and water to wash the scooter. Use soft cloth to wipe the scooter after washing to prevent scratching.

Attention:

If the scooter is frequently used in overload, high-speed, bumpy or up/downhill riding conditions, the maintenance cycle should be shortened.

For more guaranteed quality and longer service life, please use original parts, which are under normal warranty.

Warning:

If incapable of repair or adjustment on his/her own, the scooter owner is advised to send the scooter to the dealer's for maintenance and adjustment for the sake of safety.

Always choose a smooth surface road for repair and adjustment. If it's necessary to repair the scooter during a ride, please mind the traffic.

Warning:

Do not use pressure washer to wash the scooter, especially around the battery compartment. Do not flush the rear inner mudguard, where the charger, controller and other parts are installed behind. If the charging port on the scooter is wetted, please do not charge before the charger dries off. Contacting your dealer is recommended.

Storage Method

△ Short-term Storage:

- ① Keep the scooter in flat, steady, well-ventilated and dry area.
- ② Charge the battery to 50% full before storage to maximize battery life.
- ③ Avoid exposure under sunlight and rain to reduce damage or aging.

△ Long-term Storage:

- ① Remember to have a cycle of charge and a discharge at least every 2 months and charge the battery to 50% full before storage to maximize battery life.
- ② Charge the battery to 100% full after long-term storage.
- ③ Check all the parts carefully to make sure that there is no problem before riding it. If there's any problem, take the scooter to your dealer for maintenance or repair.

Warning: Please take out the battery from the scooter when long-term storage.

Regular Maintenance Checklist	
Regular Safety and Performance Check	Brakes
	Lights
	Horn
	Electric Parts
	Tyres
Structural Check	Lubrication
	Wheel Bearing
	Vibration Damper
	Side Stand
	Steering Bearing
Major Parts	Battery
	Main Wiring Harness
	Control System

Troubleshooting List		
Malfunction Description	Causes	Troubleshooting
No output when switched on	<ol style="list-style-type: none"> 1. Dead battery 2. Battery not connected 3. Alarm failure 	<ol style="list-style-type: none"> 1. Charge the battery. 2. Check if it's properly connected 3. Replace Alarm
Motor failure when turning the twist grip after switched on	<ol style="list-style-type: none"> 1. Battery voltage is low 2. The power off switch is enabled when pulling the brake lever 3. The Parking Mode has not been turned off yet 	<ol style="list-style-type: none"> 1. Charge the battery. 2. Do not pull the brake lever when twisting the twist grip. 3. Check "Start the Scooter" section. Check if the side stand is on.
Battery charge failure	<ol style="list-style-type: none"> 1. Not properly connected 2. Battery temperature is too high or too low 	<ol style="list-style-type: none"> 1. Check whether the plug is loosened. 2. Wait for it to achieve normal temperature

Troubleshooting List		
Malfunction Description	Causes	Troubleshooting
Dropping speed or range	<ol style="list-style-type: none"> 1. Low battery level 2. Under-inflation of tyres 3. Frequent braking and overload 4. Battery aging or normal capacity loss 5. Low battery capacity resulting from low temperature 	<ol style="list-style-type: none"> 1. Charge the battery and check if the plug is properly plugged in and whether the charger is damaged. 2. Check the tyre inflation every time. 3. Develop good riding habits. 4. Replace the battery. 5. Normal situation.
Sudden stop during a ride	Dead battery	Charge the battery.
	Identify the fault causes in reference to the meter panel fault codes.	

Fault Code List			
Fault Code	Meaning	Causes	Troubleshooting
30	Battery overcharge	Battery in overcharge protection	Turn on headlight to discharge. Check if the charger is broken or wrong type.
31	Battery overcurrent	Battery in overcurrent protection	Stop charging and check if the charger is failed.
32	Charge overcurrent	Stays in 0°C for over 30 sec or -20°C for over 3 sec	Put the battery indoor until battery temperature is over -15°C
130	Battery overdischarge	Battery level is too low and the BMS is about to enter protection mode	Stop riding and charge the battery.
131	Battery overcurrent	Battery is undervoltage or overvoltage	Check if the charger is failed.
132	Battery over-temperature	Battery temperature is too high	Stop riding and park the bike in the shade to let the battery cool down.

Fault Code List			
Fault Code	Meaning	Causes	Troubleshooting
133	Battery below-temperature	Battery temperature is too low	Charge the battery after it reaches the operating temperature range.
60	Communication Module failure	SIM card identification failure	Contact your dealer.
67		SIM card unpaid or weak signal	
62		GPS failure	
63		GPS Antenna short circuit	
64		GPS Antenna open circuit	
65		SN code are not written or Smart central controller serial code are not written	

Fault Code List			
Fault Code	Meaning	Causes	Troubleshooting
10	FOC stop working	Motor stucked	Check if the motor is stucked.
11		Undervoltage or overvoltage	Check if the charger is intact.
12		Overcurrent	Contact your dealer if happens often.
13		Controller overheat	Park the bike in shade and wait for it to cool down.
110	FOC failure	MOSFET failure	Contact your dealer.
		MOSFET driver failure	
111	FOC varification failure	Non-original Controller or communication failure	Restart the bike. Contact your dealer if it does not work.
190	FOC Communication failure	Can not receive Controller's data	Contact your dealer.

Fault Code List			
Fault Code	Meaning	Causes	Troubleshooting
120	Motor failure	Motor Hall Sensor failure	Contact your dealer.
		Motor cord disconnected	
140	Twist Grip failure	Twist Grip Hall Sensor failure	Contact your dealer.
191	Battery communication failure	BMS can't return data or returned data is incorrect	Check the Connector is properly plugged. Contact your dealer if happens often.
99	Communication Harness failure	Smart Central Controller or Harness Assembly failure	Contact your dealer.
71	Light Control	Gyroscope failure	Contact your dealer.
161	Locked bike	The bike is remotely locked by the server.	Contact your dealer.

Troubleshooting List		
Malfunction Description	Causes	Troubleshooting
131 displayed	Over discharging	Stop the scooter and restart later.
132 displayed	Battery overtemperature	Stop riding and let the battery cool down.
133 displayed	Battery undertemperature	Charge the battery after it reaches the operating temperature range.

Technical Parameters

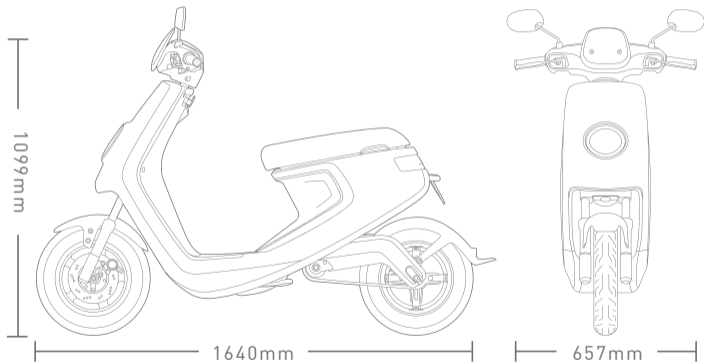

Key Features			
Product Weight	60Kg	Gradeability	Dynamic: 15°
Rated Voltage	48V	Maximum Designed Speed	45km/h 40km/h 25km/h
Maximum Load	100Kg	Braking Distance	≤4.5m (30km/h)
Designed Capacity		1 or 2 Persons	

Battery System		
	M1 Sport	M1 Pro
Voltage	48V	48V
Capacity	26Ah	32Ah
Standard Charging Current	4A	4A
Maximum Discharging Current	40A	40A

Frame	
Front Damper	Oil Damping Direct Acting Shock Absorber
Rear Damper	Rear Mono-Shock
Front Tyre Specifications	90/90-10 Rim: 2.15x10
Rear Tyre Specifications	90/90-10 Rim: 2.15x10
Front Brake Mode	180 mm Dual-Piston Hydraulic Disk Brake
Rear Brake Mode	Drum Brake
Minimum Ground Clearance	126mm
Seat Height	710mm

Power System		
	M1 Sport	M1 Pro
Motor	Tailored Motor by Bosch GmbH	Tailored Motor by Bosch GmbH
Motor Control Mode	FOC Vector Control	FOC Vector Control
Motor Rated Power	800W	1200W
Motor Maximum Power	900W	1600W
FOC Controller Max. Current	40A	40A

Electrical System	
Headlight	12V LED
Turn Indicator	12V LED
Taillight	12V LED
Brake Light	12V LED
Meter Panel	12V LCD
Central Control Unit	12V
USB Charging	5V/1A

Maintenance Record

Date	Malfunction Description	Causes and Troubleshooting	Service Station	Serviced by	Remarks

Maintenance Record

Date	Malfunction Description	Causes and Troubleshooting	Service Station	Serviced by	Remarks

Maintenance Record

Date	Malfunction Description	Causes and Troubleshooting	Service Station	Serviced by	Remarks

Maintenance Record

Date	Malfunction Description	Causes and Troubleshooting	Service Station	Serviced by	Remarks



V1.4